



LODGE

• CAST IRON •

**Camp
Dutch Oven
Cooking**

101



*I'm cast
to last!*

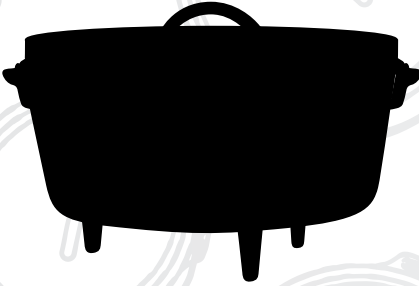
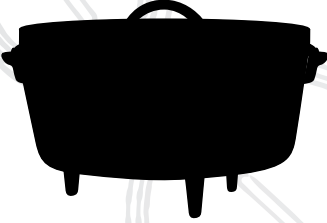
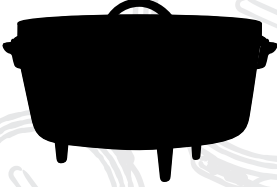
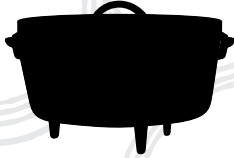
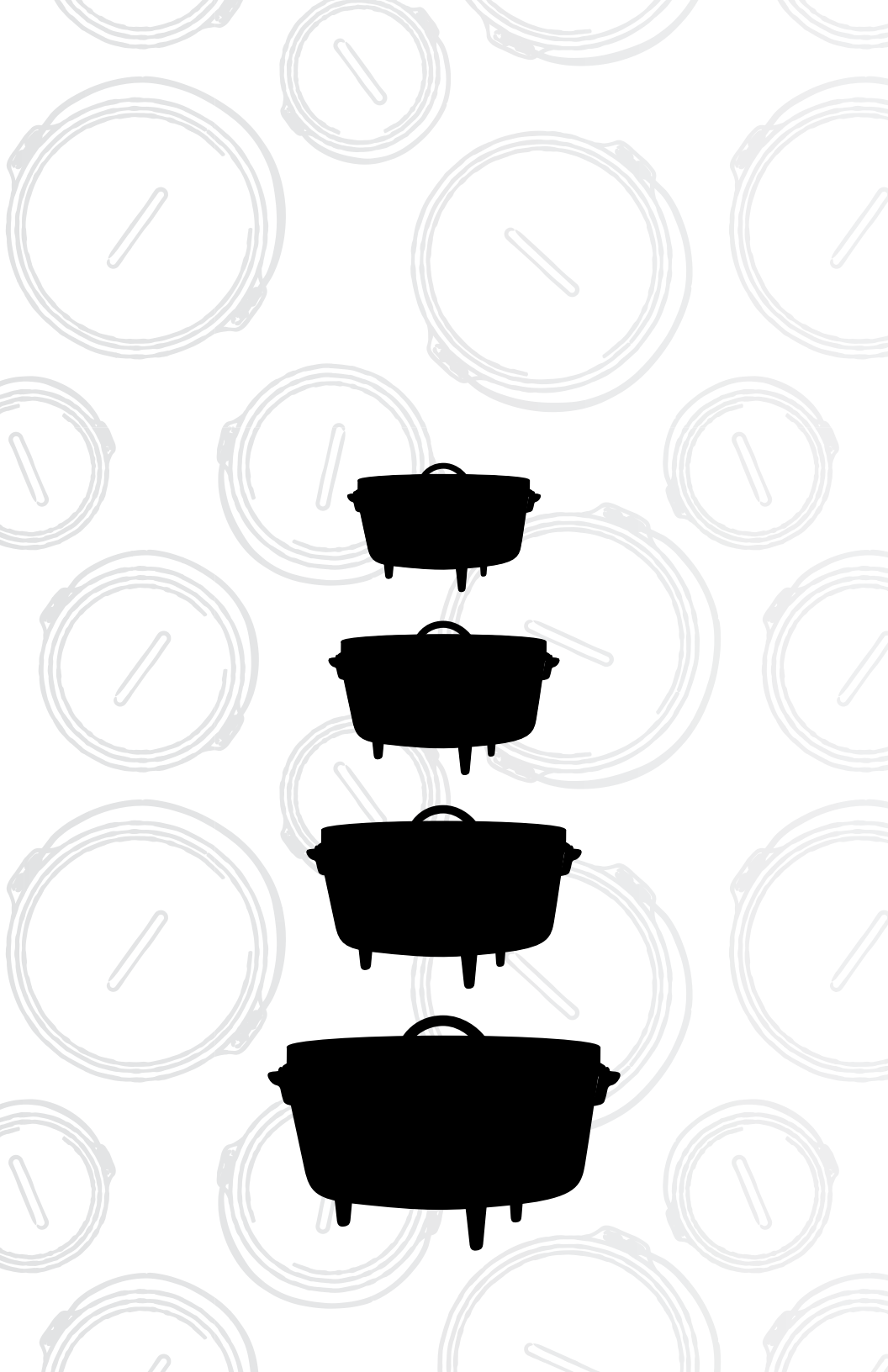



LODGE

• **CAST IRON** •

**Camp
Dutch Oven
Cooking**

101



SAVOR
the outdoors™



Lodge Mfg Co.

S. Pittsburg, TN 37380

1.833.LODGEUSA (1.833.563.4387)

@lodgecastiron

Copyright © 2021 by Lodge Manufacturing Company. All rights reserved.

This book, or parts thereof, may not be reproduced in any form without the expressed written permission of Lodge Manufacturing Company.

Designed, written, and compiled by Lodge Cast Iron.

TABLE OF CONTENTS

- 4 HISTORY OF CAMP DUTCH OVENS**
- 6 ANATOMY**
- 8 SELECTION**
- 10 TOOLS**
- 12 CHIMNEY STARTER**
- 14 TEMPERATURE**
- 16 COAL BRIQUETTES**
- 18 ROTATE THE LID**
- 20 USE AND CARE**
- 22 RESEASONING**
- 24 RECIPES**
- 51 NOTES**
- 55 COOKING SOCIETIES**

HISTORY

OF CAMP DUTCH OVENS

From the colonial hearth fires, to the campfires of Lewis and Clark, to the chuckwagon trails, cast iron camp Dutch ovens cooked the food that kept America going. They fed the colonists, helped tame the wilderness, and did their share in settling the American West.

The first iron kettles and pots date back to the 7th and 8th centuries, but by 16th century Europe, the art of casting iron was widespread and cast iron cookware had become a valued commodity. Although the Colonists brought their cast iron pots with them to the New World, soon they were casting skillets and kettles of their own. Iron cookware was treasured so much that George Washington's mother even specified the recipient of her cast iron kitchenware in her will.

Paul Revere, a blacksmith and silversmith by profession, is credited with creating the flanged lid of the camp Dutch oven. This improvement, combined with the legs on the bottom, allow for a fire source to be both over and under the pot, making it an actual baking oven at the hearth or campfire. In 1804, President Thomas Jefferson commissioned Lewis and Clark to explore America's new territory, acquired with the Louisiana Purchase. During the amazing two year Corps of Discovery, many things were discarded to lighten the load, but never their cast iron pots. In fact, the only manufactured items that returned with them were their guns and iron pots. Little did they know that this would become the preamble to the settling of the American West. And settle we did, but never without our cast iron cookware. To make the journey and lay claim to their parcel of Western America, each settling family packed their Conestoga wagon with only their most necessary and cherished possessions.

In 1896, Greece held the first modern Olympic Games, the Klondike Gold Rush began, and William McKinley was elected president. Utah became a state and declared the cast iron Dutch oven to be the state's official cooking pot. Fanny Farmer published her first cookbook "The Boston Cooking School Cook Book", which made cooking history by including specific instructions and accurate measurements. It was also in this year that Joseph Lodge and his wife settled in the tiny town of South Pittsburg, Tennessee (population 3,100) and opened his first foundry. Originally named The Blacklock Foundry after Joseph Lodge's friend and minister, the company gained success until May of 1910 when it burned down. Just three months later and a few blocks south, the company was reborn as Lodge Manufacturing Company. Joseph Lodge created a legacy of quality that has thrived through two World Wars and the Great Depression and is still carried on by his family today. While many worthy competitors have fallen by the wayside, Lodge's dedication to quality, technology, and employees have helped it not only survive but flourish.



ANATOMY OF A DUTCH OVEN

Whether you are new to camp oven cooking, or a seasoned pro looking for the next piece in your collection, here is an explanation of what makes a great camp Dutch oven.

IRON

The walls and bottom of the oven should be consistent and relatively smooth with only occasional and/or very small inclusions (pits) in the metal surface. Poor castings can cause hot spots, and even warping and cracking.

HANDLE

A heavy gauge wire bale can be used for hanging the oven over the hearth or campfire. It also helps in transporting meals for serving.

LID

A little play in the lid is acceptable, but loose lids or lids with wobble may allow heat to escape, increasing cooking time, and creating poor temperature control inside the camp oven. The flange along the rim holds coals in place. The lid can also be inverted and used as a second cooking surface.

LEGS

Three integral legs allow the oven to be perfectly spaced over hot coals without wobbling on uneven surfaces.

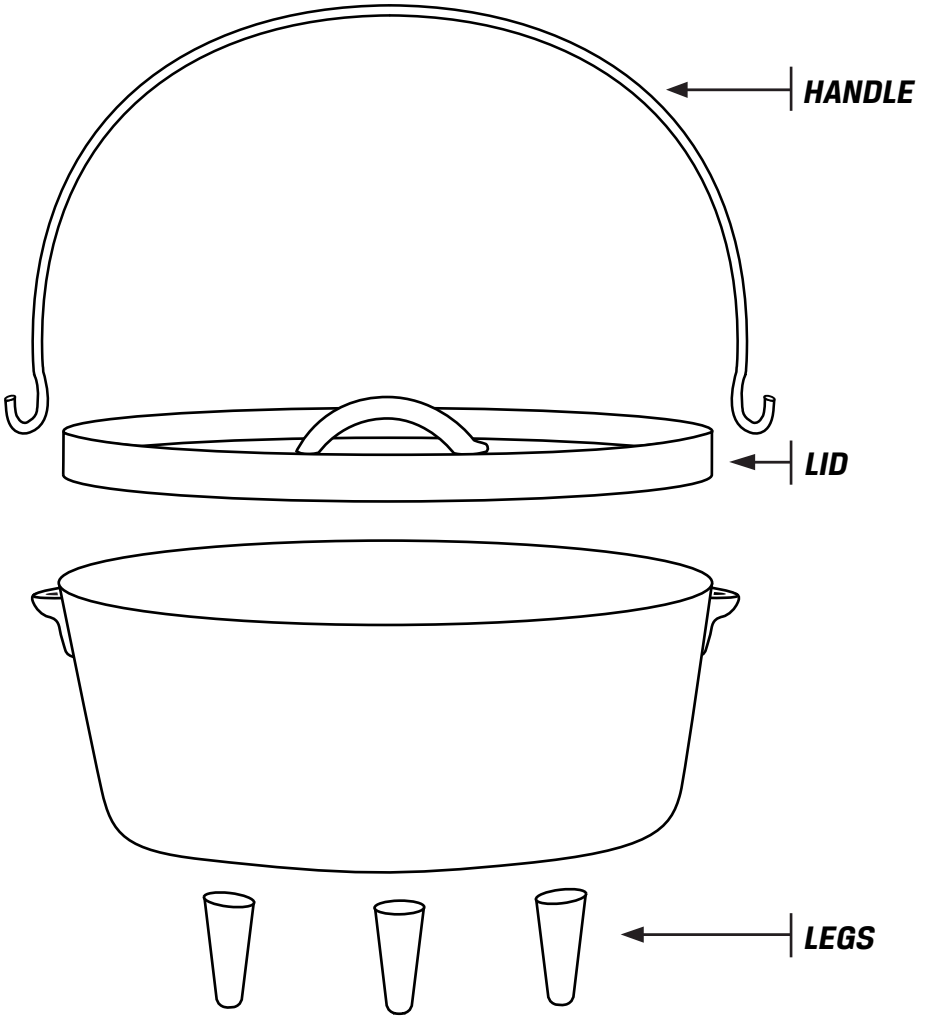

DUTCH OVEN SELECTION

Lodge's cast iron Dutch ovens come in different sizes and capacities, from the small 6 inch oven all the way up to a 14 inch. Unless planning to cook for large groups of people, most cooks have found the 10 inch and 12 inch ovens adequate for the majority of outdoor use. The following is a description of the capacity of the various popular oven sizes.

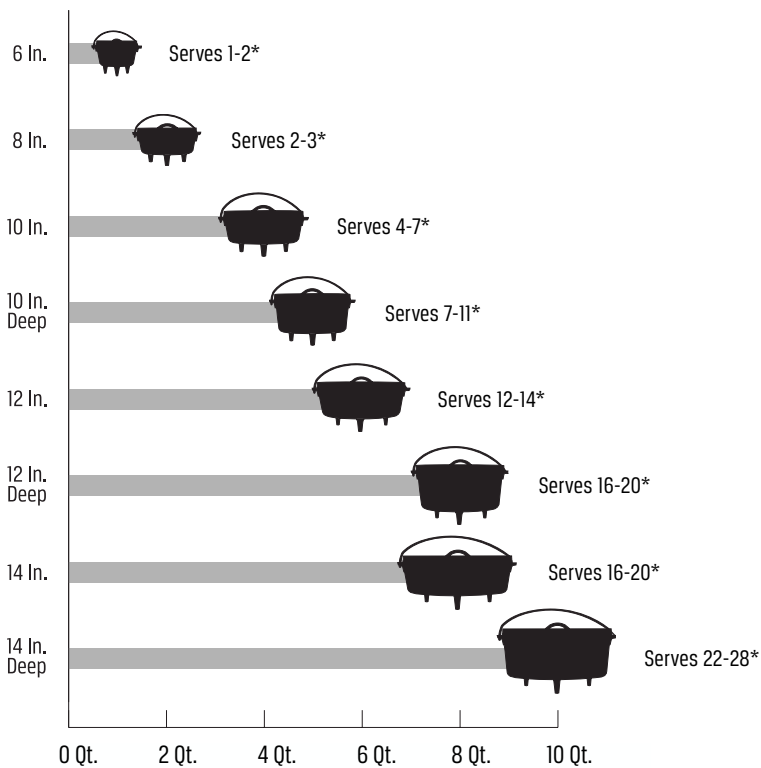

*Servings per Dutch Oven are approximate.

It's generally accepted that the ovens with shallow sides are called "bread" ovens. When baking, the heat source on the lid needs to be close to the object being baked. Your rolls or biscuits will then be brown on the top as well as the bottom. The ovens with deeper sides allow room to cook meats, vegetables, soups, and stews. Not only are the oven contents close to the lid, but foods containing moisture produce some steam, which helps maintain an even oven temperature.



USEFUL TOOLS FOR COOKING

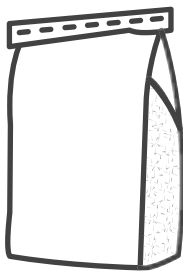

Charcoal



Vegetable Oil

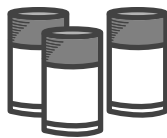

Herbs and Spices

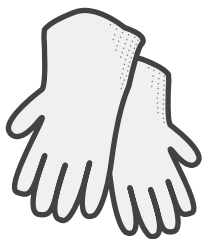

Gloves

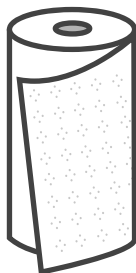

Paper Towels



Tongs



Chef's Knife



Lid Lifter

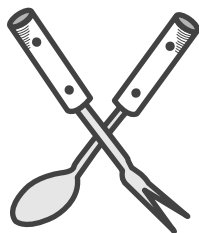

Spoon and Fork

There is no rocket science involved in great outdoor cooking. We promise. It simply takes a little preparation, a good recipe, and some hungry family, friends or neighbors. However, it is helpful to have everything you need at hand so you're not running back and forth between the house or tent.

Wood was the traditional fire source for cooking outdoors. Today we have charcoal briquettes. Whether a novice or a champion camp oven chef, charcoal briquettes offer easier and better heat control. With each passing year, state and national parks place more restrictions on gathering wood and building open fires. All are really good reasons that *Camp Oven Cooking 101* will teach the charcoal briquettes method. Use a really good quality charcoal but not a pre-treated, fast start charcoal. Quality charcoal will burn longer and more consistently, and make the difference between a great meal and a meal that is burned or raw!

For those of you who have over-doused your charcoal with lighter fluid to light your charcoal grill—just say no. It will make your charcoal burn too fast. A small amount of lighter fluid combined with a chimney starter is the way to get charcoal hot.

USING A CHIMNEY STARTER

Load charcoal briquettes into the top of the starter. Crinkle a piece of newspaper and insert into the large opening on the bottom of the starter. Light the newspaper with a match and zap—hot coals in about 15 minutes. If you are cooking something that takes longer than 45 minutes, you will need to keep adding hot coals to your oven. A charcoal starter is invaluable for keeping a stash of hot coals on hand.

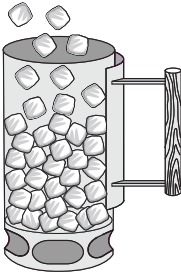

- 1.** Load charcoal briquettes into the top of the starter

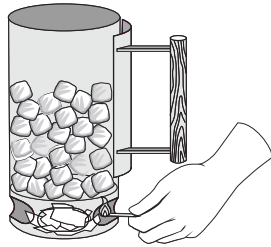

- 2.** Crinkle a piece of newspaper and insert into the large opening on the bottom of the starter

CREATE A WIND SHELTER

Choose a cooking site with as much wind shelter as possible. Create a wind break so that the direction of the wind is at your face. You can use patio pavers, bricks, concrete blocks or stones to create a wind break. You can also use a camp oven cooking table which will raise the cooking surface up off the ground, making it easier to tend to the food. Grab a cooler of your favorite beverage and make plenty of room for friends. Just as everyone gathers in the kitchen in a home, everyone gathers around the camp oven cook.

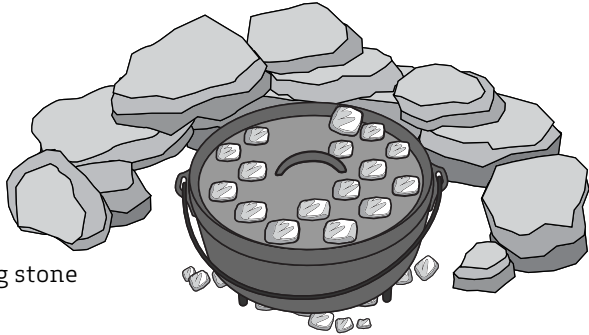

Wind break using stone

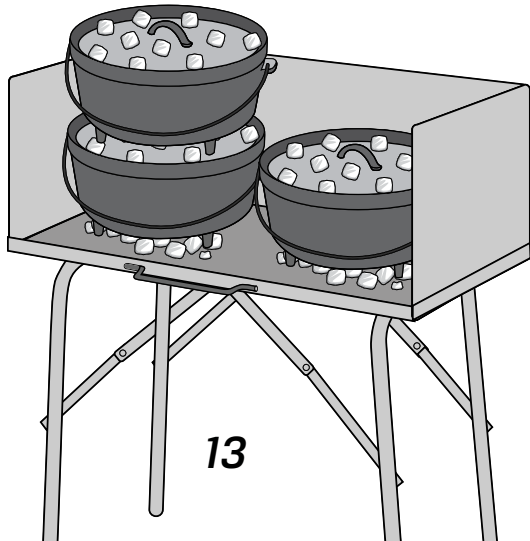

Cooking table
with windscreen

DETERMINE COOKING TEMPERATURE

Most cooking in a Dutch oven is done at 350° F. To determine the amount of coals required to produce a 350° F oven, just double the diameter of your oven. If you are using a 12 inch oven, you will need 24 coals, while a 14 inch oven will require 28 coals, and so forth. If you are using a "deep" oven, add 2 to 4 more coals.

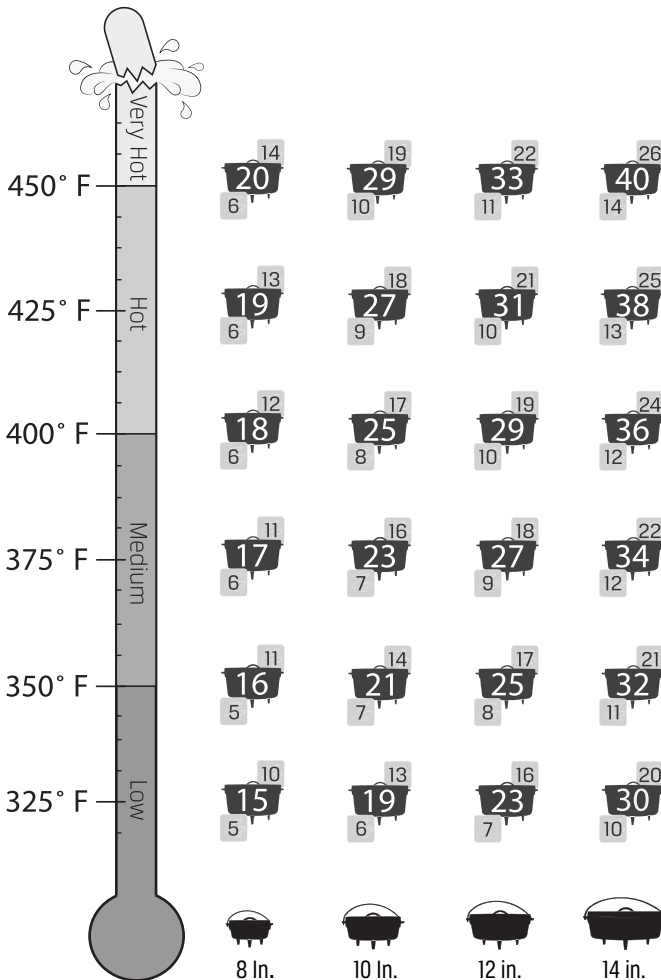

PREPPING YOUR *DUTCH OVEN*

Start your coals about 15 minutes ahead of cooking. As your coals are getting hot, prepare your ingredients for cooking. To prepare the oven, apply a light coat of vegetable oil or cooking spray to the cooking surfaces of the oven.

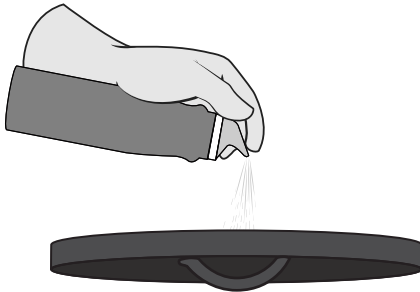

1. Spray oil on top and bottom of lid



2. Lightly coat oil to the inside and outside surfaces of oven

PLACING THE COAL BRIQUETTES

Remember Physics 101—heat rises. Therefore, more coals are needed on the lid to put the correct amount of heat into the oven from above and fewer coals are needed to put the correct amount of heat into the oven from the bottom. Also, too many coals on the bottom of the camp oven will cause your food to burn.

Each briquette increases (or decreases) the oven temperature about 10° F. Ash accumulation decreases the efficiency of the coals. Use a whiskbroom to brush ash away from the top and bottom.

With friends around and beverage in hand, tend your food. This is not a "set it and forget it" process, but that's what makes it fun. You will have to remove the lid occasionally. Plan a place to put it that won't contaminate the cooking surface of the lid with dirt or grass. A lid stand is handy to have, but a couple of clean rocks will also serve the purpose. Caution: Removing the lid too often may extend cooking time, and cause uneven heat distribution.

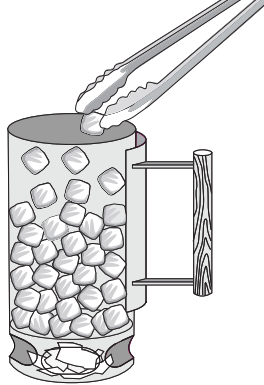

- 1.** Using tongs, remove hot coals from Charcoal Starter

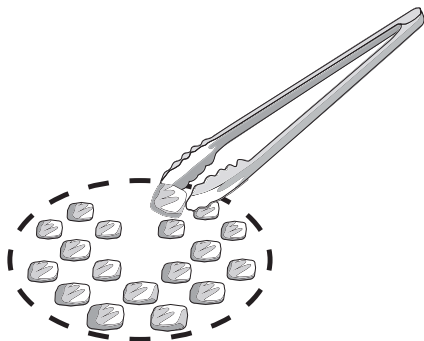

- 2.** Place $\frac{1}{3}$ of the coals in a random ring pattern under the bottom of the oven



- 3.** Set the oven over the bottom coals



- 4.** Place $\frac{2}{3}$ of the coals in a random checkerboard pattern on the lid



- 5.** Use a whiskbroom to sweep ash away from the top and bottom

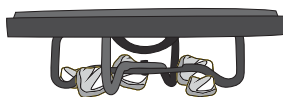

- 6.** Keep your lid out of the dirt or flip it over and use as a griddle with the Lodge Lid Stand

ROTATING THE LID

To maintain an even oven temperature and prevent "hot spots", lift and rotate the oven $\frac{1}{4}$ turn every 15 minutes. Then rotate the lid $\frac{1}{4}$ turn in the opposite direction. You will find that a pair of welding gloves and a lid lifter will be necessary tools for camp oven cooking.

Check your food occasionally to be sure that it is not cooking too fast—or not fast enough. When moving the lid, take some care or your food will be flavored with ashes! If it is necessary to add or remove briquettes, do so in the same proportions on the top and bottom.

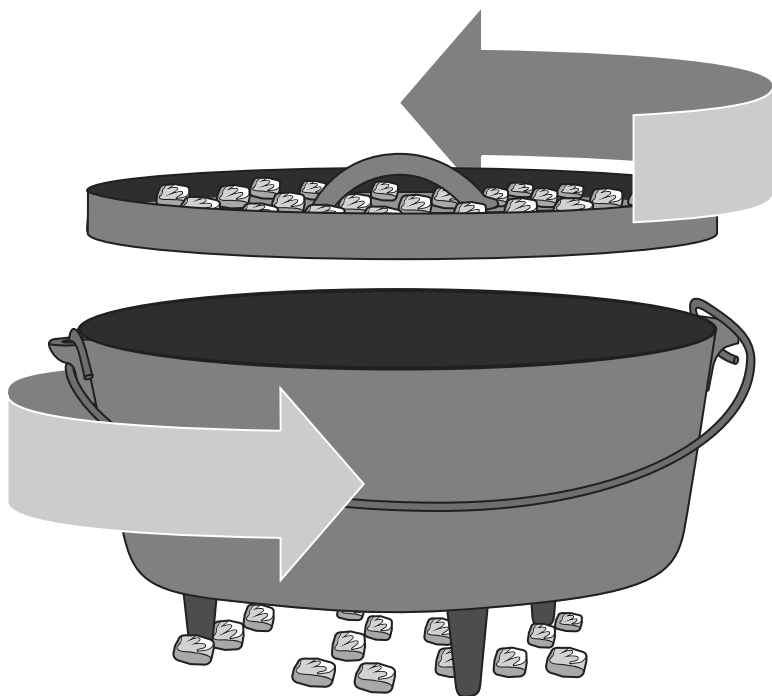

If the food you are cooking is going to take a while, new coals will have to be added every 45 to 60 minutes. The wind conditions and the brand of charcoal will cause the time to vary. Watch your food, and when the cooking process slows, it's time to add some new coals and remove spent coals and ashes.

To fry or sauté in your camp oven, all the coals will be on the bottom. Just like frying in your kitchen, more bottom heat is required. Some recipes will call for sautéing some ingredients and then adding the remainder to cook. First, you'd put all the coals on the bottom to sauté. When the remaining ingredients are added and the lid is in place, move the necessary coals from the bottom to the top, keeping the $\frac{1}{3}$ to $\frac{2}{3}$ rule. When your food is ready, keep a few coals under the oven and on the lid to keep it warm until ready to serve. With a little practice, you will be cooking like a pro.

USE AND CARE

Now that you have your oven, you need to know how to care for it so it will last a lifetime.



- 1.** Scrub with thick brush and rinse with water



- 2.** Dry interior and exterior surfaces thoroughly



- 3.** Wipe interior and exterior surfaces with a light coat of oil

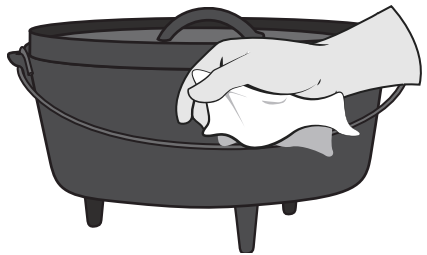

- 4.** Dry interior and exterior surfaces thoroughly

Cleaning

After cooking in your cast iron cookware, clean it with hot water and a stiff brush. Never use harsh detergents to clean iron as it will remove the seasoning. Avoid putting very hot cast iron into cold water. The resulting thermal shock can cause it to warp or crack.

Drying

Towel dry your cast iron thoroughly. While the utensil is still warm from the hot water wash, immediately wipe a light coat of cooking spray or vegetable oil on all of the interior and exterior surfaces.

Storage

Store your cast iron in a cool, dry place. Folded paper towels should be placed between the lid and the utensil to allow air to circulate. Place a few paper towels inside the oven.

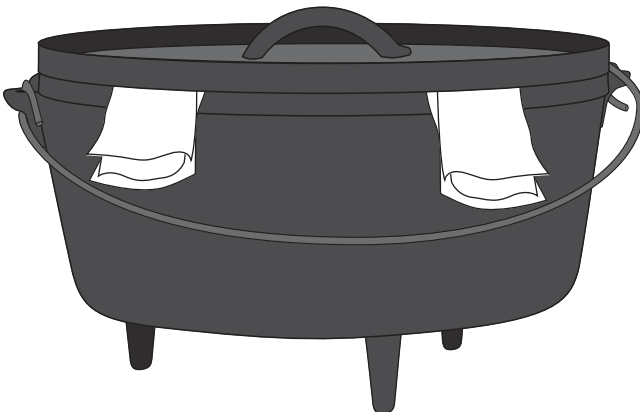

RESEASON YOUR DUTCH OVEN

If you notice a metallic taste or your cookware shows signs of rust, simply wash the cookware with soap and hot water and scour off the rust.

Pre-heat the kitchen oven to 350° F. If you have three racks remove one prior to pre-heating. Wash the camp Dutch oven with hot, soapy water and a stiff brush. Next, spray a very thin coat of melted shortening or vegetable oil inside the oven and on the interior and exterior surfaces of the lid.

Lower both your oven racks to the two bottom positions. Line the lower rack with aluminum foil (to catch drippings), and place the camp Dutch oven upside down on the middle rack of the oven and bake for 1 hour. Place the lid beside the oven on the same rack. If the lid will not fit you can simply place the lid on top of the camp oven legs. Turn the oven off leaving the cookware in the oven until cool.

Some of the larger camp dutch ovens may be too large for your oven. In this case you can place the oven upside down on your grill with the lid on the oven legs. Place the grill lid over the oven and grate and remove when the cookware turns dark. Allow to cool.

For questions regarding use and care of Lodge Cast Iron cookware you can contact customer service at **423-837-7181**, or visit our website at **www.lodgemfg.com**.



1. Wash and scour off any rust



2. Dry inside and outside of the oven



3. Spray a thin coat of melted shortening or vegetable oil

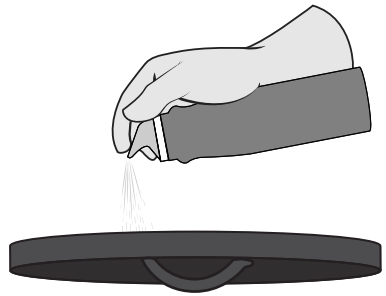

4. Spray the lid and exterior surfaces of the oven

5. Bake for one hour and allow oven to cool

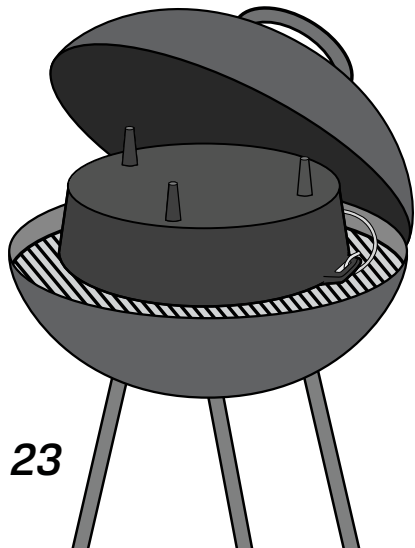

REC



IPES

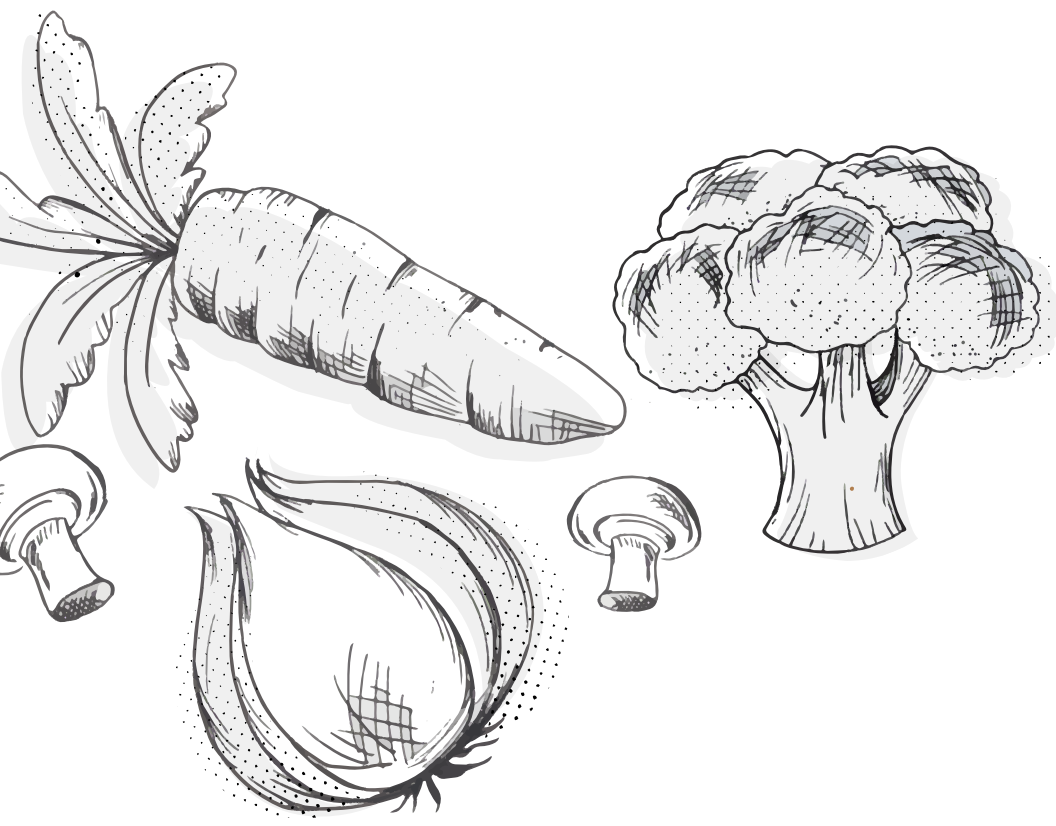

MOUNTAIN MAN BREAKFAST



2 pounds sausage

2 pounds frozen hash brown potatoes

8 eggs, beaten with ¼ cup water

2 cups cheese, grated

Over a full bed of hot coals, fry and crumble sausage. Remove cooked sausage and drain on paper towels. Using the sausage drippings in the pan, brown potatoes and spread them evenly in bottom of Dutch oven. Place cooked sausage over potatoes. Pour eggs over sausage layer. Sprinkle top with cheese. Cook with 8 coals underneath Dutch oven and 16 on top for 20 to 25 minutes, until eggs are cooked.



GOOD OLD FASHIONED FAMILY STEW



1 pound of stew meat, or chuck cut to 1 inch cubes

2 large, yellow onions, diced

4 potatoes, peeled, cut into 1 inch cubes

1 cup of baby carrots

½ cup of celery, diced

*½ cup each of your choice of parsnips,
mushrooms or other veggies, diced*

2 beef bouillon cubes

2 cans of mushroom soup

browning sauce

seasonings, salt and pepper

Use full pattern of briquettes on bottom to heat Dutch oven and ¼ inch of cooking oil. Cook other veggies you may wish to add. Put in onions and brown meat together. Drain off excess oil. Add potatoes, carrots, and all bouillon cubes, mushroom soup (if used), salt, pepper and seasonings, which may include a seasoning salt, curry, oregano, cloves, bay leaf, etc. Add enough hot water to cover veggies. When recipe reaches a simmer, pull enough briquettes to maintain the simmer, stir occasionally and cook until the meat and carrots are fork tender. Add cornstarch thickener (if used), and browning sauce as desired.

FINADENE CHICKEN



Sauce:

Finadene Sauce (all purpose sauce from Guam)

1 medium onion, chopped

1 (15 oz.) bottle of soy sauce

3 hot peppers, chopped

1 cup white vinegar

Chicken:

5 or 6 bone-in chicken breasts

6 slices of raw bacon

3 bell peppers, sliced (green, yellow, red or orange)

Use a food chopper to chop the onions and hot peppers; it chops them much finer than by hand. Combine sauce ingredients in a bowl and stir. Add more soy sauce or vinegar until you obtain the desired taste. The chicken can be marinated in the Finadene Sauce prior to cooking for extra flavor.

Lay the raw bacon in the bottom of a large Dutch oven. Add the chicken breasts. Layer the bell peppers on top of the chicken. Pour in about $\frac{2}{3}$ of the Finadene Sauce. Reserve the rest of the sauce to dip the chicken in when you're eating. Put the lid on the Dutch oven and cook with 21 coals on top and 11 on the bottom until the chicken is done (about 1½ hours). Take the lid off during the last 30 minutes of cooking.

DUTCH OVEN POTATOES



1 large potato per person

½ yellow onion per person

1 to 1½ pounds of bacon, cut into squares

1 pound shredded medium cheddar cheese

salt or seasoning salt, pepper

Line the bottom of your 12 inch Dutch oven with bacon squares and cook half way. Slice potatoes evenly into bite-sized pieces, about $\frac{1}{4}$ inch thick. Slice onions into $\frac{1}{4}$ pieces, that will break up as you cook. Add onions and potatoes to the pot. The potatoes will cook down, so heap them to the brim for maximum potatoes per pot. Add salt or pepper, or use a seasoning like Lawry's. If you like, add a couple of tablespoons of vegetable oil.

Cover and place oven over a full bed of gray coals. When the ingredients have heated, pull $\frac{1}{3}$ of the coals from then bottom and place on top, around the edge of lid. Turn the ingredients every 20 minutes and maintain $\frac{1}{4}$ inch of liquid, to prevent burning. Too much liquid makes mushy potatoes; use a turkey baster to remove any excess. After turning ingredients, rotate the pot one half turn clockwise and the lid one half turn counter-clockwise. Cook until the potatoes are fork tender, usually about 45 minutes. If you wish, after removing pot from coals, cover cooked ingredients with shredded cheese and replace lid until cheese is melted.

BEST BUTTERMILK BISCUITS



- ½ cup butter*
- 2½ tablespoons granulated sugar*
- 1 beaten egg*
- ¾ cup buttermilk*
- ¼ cup club soda*
- 1 teaspoon salt*
- 5 cups Bisquick™ biscuit mix*
- ¼ cup melted butter (for top of biscuits)*

Grease and heat a 12 inch Lodge Dutch oven with 8 coals on the bottom and 17 coals on the top. Combine all ingredients. Knead the dough by hand until smooth. Flour your hands. Pat the dough flat to $\frac{3}{4}$ inch thickness on waxed paper and punch out biscuits with a biscuit cutter. Place biscuits on the bottom of the hot Dutch oven and bake for 12 to 15 minutes or until golden brown. Rotate the oven and lid often to prevent burn spots. Remember, these will bake from the top down. Brush golden biscuits with $\frac{1}{4}$ cup melted butter.

SOUTHWEST BAKED ONIONS



*4 large (14 to 16 oz. each) Texas Sweet onions or Walla Walla onions
olive oil
salt and pepper*

Place whole, unpeeled onions in a round aluminum pie pan. Drizzle lightly with olive oil. Place in bottom of camp oven and cover with lid. Place 18 coals on top and 9 on bottom; bake for about 1 hour and 15 minutes. Onions are done when easily pierced with a fork (soft but not mushy). To serve, cut an X through the top of each onion and squeeze slightly at the bottom so it opens like a baked potato. Season with salt and pepper to taste and garnish with sour cream and chives. Serves 4.



BARBECUED CHICKEN AND RIBS



- 4 cups ketchup*
- 1 cup brown sugar*
- 2 cups water*
- 1 cup vinegar*
- 2 onions, chopped*
- 2 whole chickens, cut up and skinned*
- 2 to 4 pounds ribs*
- salt and pepper*

Over a full bed of coals, sauté onions in a little bit of oil until tender. Add the rest of the ingredients for the sauce. Remove enough coals to bring to simmer. Continue to simmer, uncovered, until it gets thick. Add the ribs and cook uncovered for about an hour. Add the chicken and cook for about 2 hours, or until tender. If you want the meat to cook faster, leave the lid on the Dutch oven. However this will make the sauce runny. Makes 12 to 15 servings.

CHEESY POTATO WEDGES



4 russet potatoes
½ pound butter
⅓ cup parmesan cheese
½ teaspoon garlic powder
1 teaspoon seasoned salt
parsley flakes

Wash potatoes and cut each one into 8 wedges. Melt butter in Dutch oven. Coat potato wedges with butter on both sides. Arrange in the Dutch oven in a circular pattern. Mix cheese and spices and sprinkle over the potatoes. Sprinkle with parsley flakes and bake with $\frac{1}{3}$ of the coals on the bottom and $\frac{2}{3}$ of them on the top until you can pierce the potatoes easily with a fork. Watch the bottom heat, you may have to finish baking from the top. Don't overcook. Serves 4 to 6.

SOUTHWESTERN COWBOY OMELET



- 1 small Jalapeno pepper, minced*
- 1 onion, chopped*
- 1 tablespoon oil*
- 1 ripe avocado, chopped*
- 1 tomato, chopped*
- 8 to 10 strips of bacon, fried and chopped*
- 1 cup shredded cheese*
- 8 eggs beaten with $\frac{1}{4}$ cup milk*
- $\frac{1}{2}$ cup salsa (optional)*
- salt and pepper*

Over a full bed of coals, sauté onion and pepper in oil in a 12 inch Dutch oven until tender. Remove onions and pepper from oil. Pour beaten eggs into oven, cover and cook for 3 to 5 minutes. Combine onions and pepper with avocado, tomato, bacon and half the cheese. Spread over the eggs and fold eggs over. Sprinkle remaining cheese over the top if desired. Cut in slices and serve with salsa and rolls or tortillas.

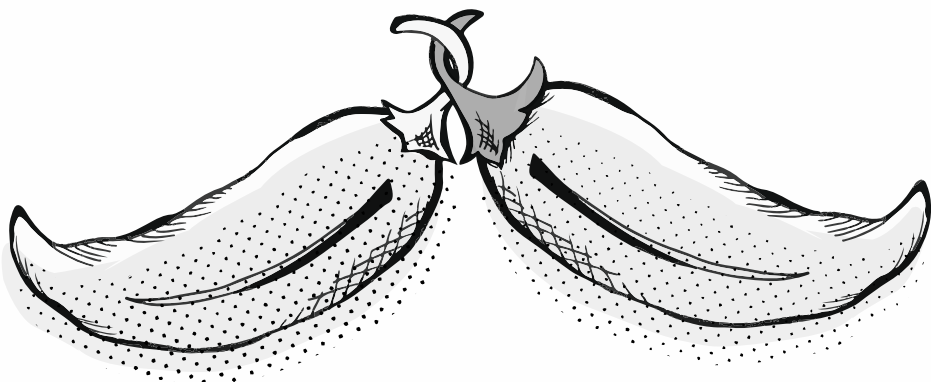

CHARLEY BREAD

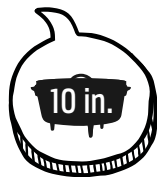

- 1 cup yellow corn meal*
- 1 cup flour*
- 1 tablespoon baking powder*
- 2 tablespoons sugar*
- 1 teaspoon salt*
- ½ cup oil*
- 1 (8 oz.) can creamed corn*
- 2 eggs*
- 1 cup sour cream*

Combine all ingredients and mix well. Pour into a well greased 10 inch Dutch oven. Bake with 6 coals under and 14 on top for about 20 minutes. Serve with honey butter.

POT ROAST



½ cup flour

1 teaspoon kosher salt

1 teaspoon cracked pepper

4 to 6 pound chuck roast

½ cup corn oil

¾ cup ketchup

3 carrots, peeled and cut in 2 inch rounds

3 yams or sweet potatoes, cut into 2 inch pieces

1 onion, coarsely chopped

4 garlic cloves

2 cups beef stock

Season the flour with salt and pepper and blend thoroughly. Roll the pot roast in the flour and salt mixture. Heat the oil in a 12 inch Dutch oven. Sear the roast for 4 minutes on each side, or until well browned. Add the ketchup, carrots, sweet potatoes, onion, and garlic. Cook the stew for 5 minutes. Add the beef stock and cover. Cook at 300° F using 7 coals on the bottom and 16 on top. Cook for 2½ to 3 hours or until the beef is very tender. Serves 6 to 8.

CHILE VERDE



- 5 pounds boneless, lean pork, cut into small cubes*
- 1 chopped onion*
- 1/3 cup finely chopped celery*
- 2 green onions, chopped, including green*
- 1 green bell pepper, chopped*
- 1 clove garlic, minced*
- 2 tablespoons oil*
- 1/4 cup flour*
- 4 cups water*
- 1 (7 oz.) can tomatillos*
- 2 cups canned chopped green chiles*
- salt to taste*

In a large Dutch oven over a bed of coals, brown cubed pork, stirring to cook all cubes. When browned, add onion, celery, green onion, bell pepper, and garlic. Stir and cook about 10 minutes, until vegetables are soft. Push mixture to one side of the oven. Add 2 tablespoons oil to pan juices. Stir in flour to make roux. Roux is a thickening agent created when mixing flour and oil. Stir until flour mixture is light tan. Add 4 cups water and stir to make a smooth gravy, stirring in the meat mixture. Bring to a boil and stir until mixture thickens. If mixture is too thick, add more water. Add tomatillos and green chiles. Add salt to taste. Simmer for 30 minute to blend flavors and tenderize meat. Serve with fresh tortillas. Serves 20.

ROSIE'S BEEF STROGANOFF



- 1 medium onion, chopped*
- 2 pounds lean ground beef or ground venison*
- ¼ teaspoon celery salt*
- ¼ teaspoon garlic salt*
- 1 cup water*
- 3 (8 oz.) cans tomato sauce*
- 1 teaspoon Worcestershire sauce*
- ½ cup sour cream*
- 1 (12 oz.) bag egg noodles, uncooked*
- salt and pepper to taste*

Brown together meat, onion, and spices in a Lodge camp Dutch oven. While meat is browning, mix together water, tomato sauce, Worcestershire sauce, and sour cream. It's ok if the sour cream is not completely blended in (mixture has a few lumps). When meat is browned, spread meat out evenly over bottom of pan. Place bag of noodles evenly on top of meat. Pour liquid mixture over top, moistening all noodles well. Cover and cook approximately 30 to 45 minutes until noodles are tender. Use 25 briquettes, 10 on bottom and 15 on top. Serves 4 to 6.



DUTCH OVEN VEGETABLES

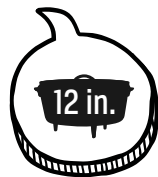

*8 cups of bite size mixed vegetables of your choice
(for example, broccoli florets, carrots, mushrooms,
onions, zucchini, butternut squash)*

¼ pound butter

8 oz. grated sharp cheddar cheese

8 oz. grated fresh parmesan cheese

salt and pepper

water

Put ¼ inch water into a 12 inch Dutch oven and add vegetables. Season generously with salt and pepper—more than seems enough. Place slices of butter on top of vegetables. Put Dutch oven over 24 hot coals until recipe is steaming, then pull out at least half of the coals. Steam vegetables until carrots are tender. Set oven off coals, remove water with baster, cover vegetables with the grated cheeses and put lid on the oven. Serve when cheese is melted.



EASY BAKED CHICKEN AND RICE



1 cup rice
2 chicken
1 package dry Lipton Onion Soup Mix
1 can chicken broth
½ cup sour cream
1 can cream of mushroom soup
water

Pour rice (not cooked) into a 10 inch Dutch oven. Place cut up chicken parts on top of rice. Sprinkle Lipton Onion Soup Mix on top of the chicken. Dilute chicken broth and cream of mushroom soup with 1 can of water. Pour this mixture over the chicken and bake with coals at 350° F with 14 coals on top and 7 coals on bottom, for at least one hour.

PORK CHOPS IN POTATO SAUCE



1 pork chop per person

1 potato for every two persons, in $\frac{1}{4}$ inch slices

1 medium yellow onion for every four persons, sliced

1 can cream of mushroom soup for every four persons

$\frac{1}{2}$ can water per can of soup

Place a 14 inch Dutch oven over 28 hot (gray) coals. Add $\frac{1}{8}$ inch of cooking oil. Brown pork chops on both sides. Remove the chops and sauté the onions. Pull out the onions, lay the chops back in and spread the onions over the chops. Lay the potato slices evenly over the onions. Mix the water and soup and pour the mixture over the ingredients. Reduce the briquettes to about half and simmer until the chops and potatoes are fork tender.

ORANGE GLAZED STUFFED PORK CHOPS



Pork:

½ cup butter

½ cup diced celery

¾ cup diced onion

1 cup fresh bread cubes

1 tablespoon parsley

1 teaspoon salt

1 teaspoon fresh ground pepper

½ teaspoon paprika

½ teaspoon rosemary

½ teaspoon allspice

1 apple, peeled and diced

10 (8 oz.) pork chops, with pocket cut in each

2 ounces olive oil

¾ cup water

Glaze:

1 cup sugar

2 tablespoons cornstarch

2 oranges, zest and juice

1 teaspoon cinnamon

14 whole cloves

½ teaspoon salt

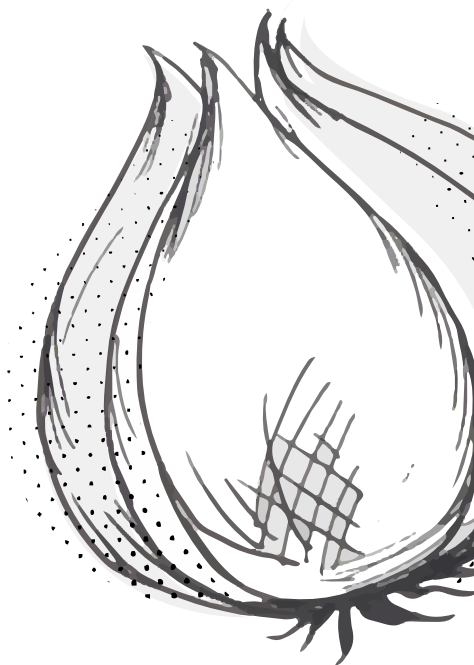

In a 14-inch dutch oven, melt butter and saute celery and onion until tender. Add remaining ingredients. Add a small amount of water, if necessary, to moisten the dressing.

Using fingers, stuff the mixture into the slit in the pork chops. Seal the pockets with toothpicks and tie with butcher string.

Brown the chops in olive oil on each side. Stand the chops on their sides and pour the water around them. Cover and simmer at about 350° F until tender, about 50 - 55 minutes.

While chops are cooking, prepare glaze by combining sugar and cornstarch in a 10-inch dutch oven. Stir in the orange zest and juice, cinnamon, cloves and salt. Cook over medium heat until sauce is thick and clear.

Place pork chops on lid for presentation. Pour sauce over them and garnish with parsley and orange slices.



PINEAPPLE UPSIDE DOWN CAKE



½ cup butter

1 cup brown sugar

1 (20 oz.) can pineapple slices

juice from pineapple slices plus enough water to make 1¼ cups

8 maraschino cherries

1 yellow cake mix

3 eggs

In a 12 inch Lodge Dutch Oven, melt butter. Sprinkle with brown sugar. Place pineapple slices over brown sugar. There should be room for 7 to 8 slices. Place a cherry in the center of each slice. In a medium bowl, combine cake mix, eggs, and reserved juice and water. Stir for 2 minutes. Spoon over pineapple slices. Place over 6 coals with 18 on lid. Cook at 350° F for 25 to 30 minutes. When done, place serving plate over Dutch oven and carefully invert. Remove oven and replace any pineapple that may have stuck. Serve warm with ice cream or whipped cream.

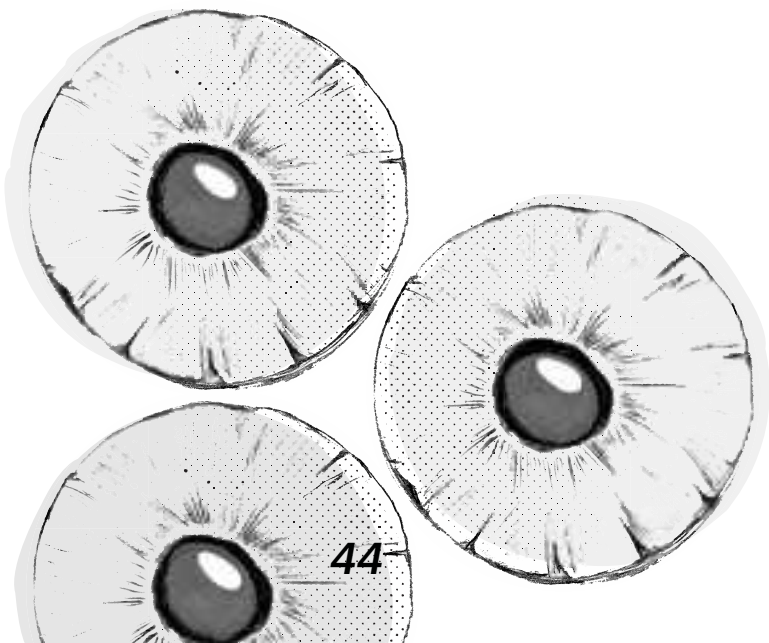

LAZY COBBLER



2 (30 oz.) cans sliced peaches, in syrup
1 package white or yellow cake mix
ground cinnamon to taste
 $\frac{1}{3}$ stick butter or margarine

Place Dutch oven over 15 hot charcoal briquettes. Pour contents of peach cans into oven. Spread dry cake mix evenly over peaches. Sprinkle cinnamon over all to taste. Cut butter or margarine into equal slices and arrange on top. Put lid on top of oven and place 10 hot charcoal briquettes in a checkerboard pattern on top. Bake for about 45 minute or until done. Spoon into bowls and add cream, ice cream or whipped cream, if desired. Serves 8.

ALMOST PUMPKIN PIE



Filling:

- 1 (29 oz.) can pumpkin*
- 1 tablespoon pumpkin pie spice*
- 3 eggs*
- 1 cup sugar*
- ½ teaspoon salt*
- 1 teaspoon vanilla*
- 1 cup evaporated milk*

Topping:

- 1 package yellow cake mix*
- 1 cup chopped pecans*
- 1 cup butter*

Mix together all filling ingredients. Pour into greased 12 inch Dutch oven. Cut butter into cake mix with pastry blender then mix in nuts. Sprinkle over top. Bake for 1 hour with 8 charcoal briquettes on the bottom and 16 on top. When done, may be served with whipped cream or ice cream. May also be served cold. Serves 12 to 16.

APPLE CRISP



Apple Mixture:

10 cups apple, peeled and sliced

¼ cup lemon juice

1 tablespoon lemon zest

¾ cup sugar

½ cup golden raisins

Topping:

1½ cups brown sugar

1½ cups oats

1¼ cups flour

¾ cup butter

2 tablespoons lemon zest

1 tablespoon cinnamon

1 tablespoon nutmeg

1 tablespoon cardamom (optional)

Spread apple mixture in bottom of 12 inch Lodge Dutch oven. Combine topping ingredients and over apple mixture. Bake at 350° F for 25 to 30 minutes, using 8 coals under and 16 on lid. Continue cooking until apples are cooked and topping is brown. Serve warm with ice cream or whipped cream. Serves 8 to 10.

EASY

TRIPLE CHOCOLATE DELIGHT



1 chocolate cake mix (add oil and eggs if needed)

1 large package chocolate chips

1 can chocolate frosting

Mix cake as per instructions on box (depending on cake mix, you might need eggs and oil). Add chocolate chips and mix in well. Line oven with aluminum foil and spray with cooking spray. Pour batter into oven and bake 30 to 35 minutes or until toothpick comes out clean. Rotate lid and oven every 10 minutes to prevent burning. Allow to cool and frost. Bake on medium heat using 6 coals on bottom and 10 on top. Serves 8 to 10. Serve with ice cream—make it chocolate for a Quad Chocolate Delight.

BAKED STUFFED APPLES



- 6 baking apples*
- ½ cups raisins*
- ½ cup slivered almonds*
- ½ teaspoon cinnamon*
- ½ teaspoon nutmeg*
- 2¼ cups water*
- 6 oz. orange juice concentrate, thawed*
- 3 tablespoons honey*

Wash and dry apples. Remove core, but do not cut all the way through the bottom of the apple. In a small bowl, combine raisins, almonds, cinnamon and nutmeg. Divide filling among apples. Using fingers, stuff apples with filling. In a small bowl, combine water, orange juice concentrate and honey. Mix until well blended. Place apples in 12 inch Lodge Dutch oven. Carefully pour orange juice mixture over apples. Bake between 350° F and 450° F or 50 minutes, or until apples are tender. Spoon excess sauce over apples before serving. Serves 6.

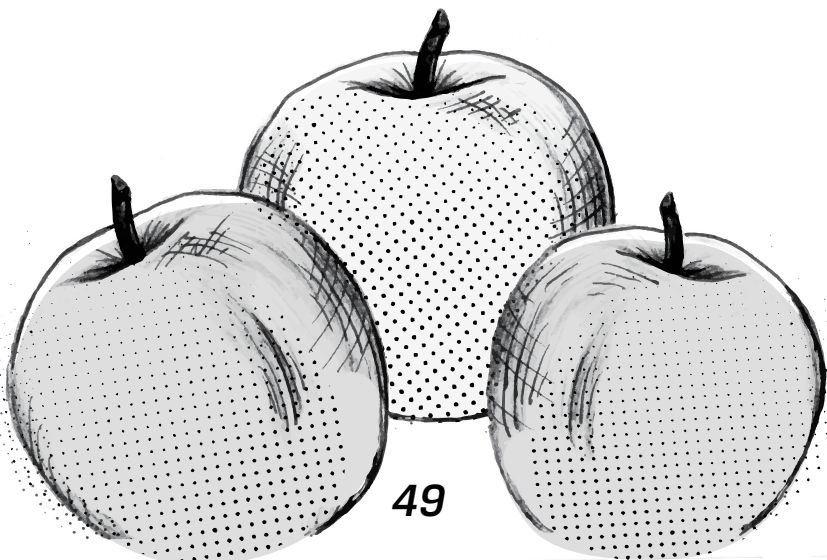

PEANUT BUTTER SWIRL BARS



- ¾ cup sugar*
- ¾ cup brown sugar*
- ⅓ cup butter*
- ½ cup peanut butter*
- 2 eggs*
- 2 teaspoons vanilla*
- 1 cup flour*
- 1 teaspoon baking powder*
- ¼ teaspoon salt*
- 12 oz. milk chocolate chips*

Cream butter and peanut butter with sugars. Add eggs and vanilla, beat well. Stir together flour, baking powder, and salt. Stir into peanut butter mixture. Spread into a 12 inch Lodge Dutch oven. Sprinkle chocolate chips on top and bake at 350° F for 5 minutes. Swirl chips to marbelize. Bake additional 20 minutes at 350° F. Cool, cut and eat.

DUTCH OVEN COOKING SOCIETIES

There are folks who have kept the tradition of great outdoor cooking alive and well. They gather in groups all over the country to celebrate the outdoors, and enjoy great outdoor recipes. Visit their websites to learn more about camp Dutch oven cooking, find great recipes, or how to start a Dutch oven cooking group in your area.

International Dutch Oven Society

WWW.IDOS.COM

Lone Star Dutch Oven Society

WWW.LSDOS.COM

Japanese Dutch Oven Society

WWW.JDOS.COM

Western New York Dutch Oven Society

WWW.DUTCHOVENDAVE.COM/WNYDOS/WNYDOS.HTML





Lodge Mfg Co.

S. Pittsburg, TN 37380

1.833.LODGEUSA (1.833.563.4387)

www.lodgecastiron.com | [@lodgecastiron](https://twitter.com/lodgecastiron)

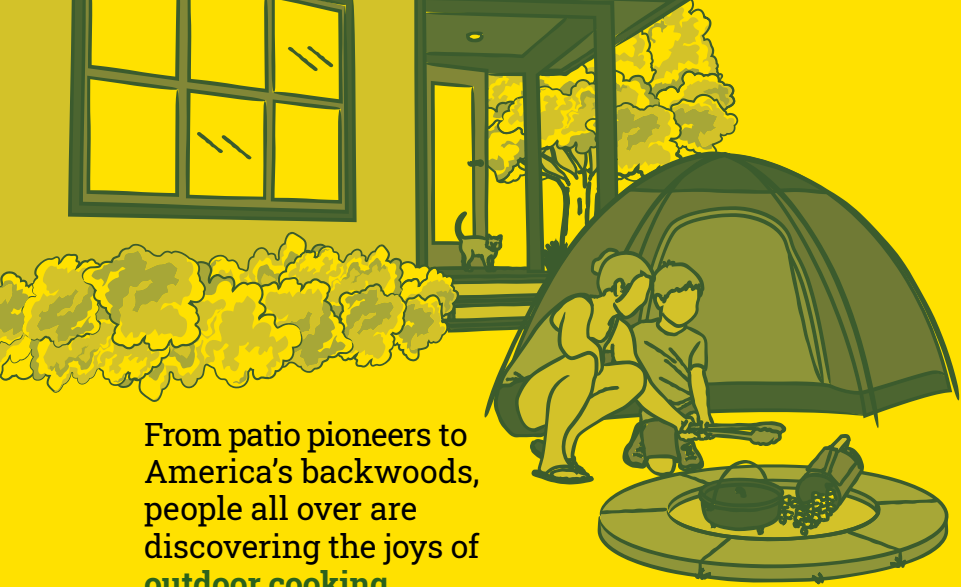

From patio pioneers to America's backwoods, people all over are discovering the joys of **outdoor cooking.**

Whether they've wrangled their meal from the grocer's freezer, or brought it back from the hunt—outdoor cooking makes any meal an event. In **Camp Dutch Oven Cooking 101** you'll learn to use a cast iron Dutch oven. With step by step instructions you'll be making meals right from the start. And you'll find that when it comes to preparing great meals, Lodge Cast Iron cooks best. So clear the patio or gather around the campfire chef—you're about to experience the fun and great tastes of **Lodge camp oven cooking.**



CB101



Lodge Mfg Co.
S. Pittsburg, TN 37380
1.833.LODGEUSA (1.833.563.4387)
Made in the USA
www.lodgecastiron.com
@lodgecastiron

